

Medium Voltage Current Transformer

CTW3-60-T50 & CTWH3-60-T50

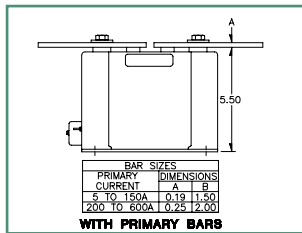
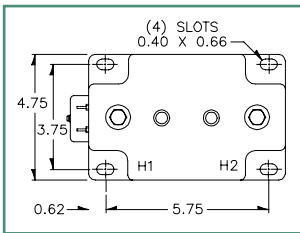
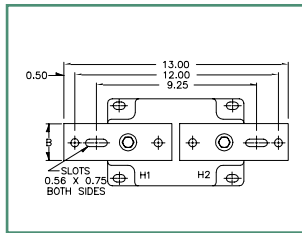
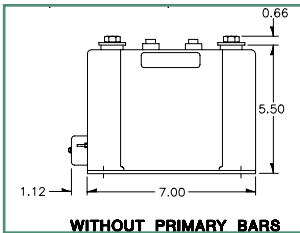
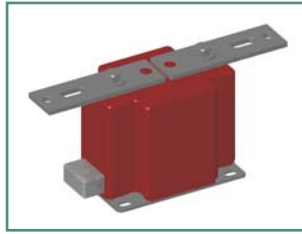
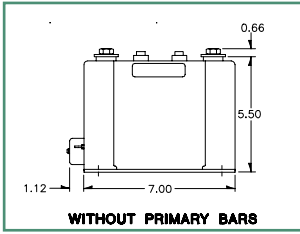

CAUTION: Use only the Belleville washers supplied. Tighten to between 25 and 30 foot-pounds. Do not overtighten.

Part Number*	Current Ratio	Relay Class	ANSI Metering Class at 60 Hz					**Thermal Current Rating 1 second RMS Amps
			B0.1	B0.2	B0.5	B0.9	B1.8	
CTW3-60-T50-050	5:5	T50	0.3	0.3	0.3	0.6	1.2	375
CTW3-60-T50-100	10:5	T50	0.3	0.3	0.3	0.6	1.2	1000
CTW3-60-T50-150	15:5	T50	0.3	0.3	0.3	0.6	1.2	1690
CTW3-60-T50-200	20:5	T50	0.3	0.3	0.3	0.6	1.2	1900
CTW3-60-T50-250	25:5	T50	0.3	0.3	0.3	0.6	1.2	2700
CTW3-60-T50-300	30:5	T50	0.3	0.3	0.3	0.6	1.2	2700
CTW3-60-T50-400	40:5	T50	0.3	0.3	0.3	0.6	1.2	4720
CTW3-60-T50-500	50:5	T50	0.3	0.3	0.3	0.6	1.2	4720
CTW3-60-T50-750	75:5	T50	0.3	0.3	0.3	0.6	1.2	8630
CTW3-60-T50-101	100:5	T50	0.3	0.3	0.3	0.6	1.2	8630
CTW3-60-T50-151	150:5	T50	0.3	0.3	0.3	0.6	1.2	14380
CTW3-60-T50-201	200:5	T50	0.3	0.3	0.3	0.6	1.2	17250
CTW3-60-T50-251	250:5	T50	0.3	0.3	0.3	0.6	1.2	17250
CTW3-60-T50-301	300:5	T50	0.3	0.3	0.3	0.6	1.2	37800
CTW3-60-T50-401	400:5	T50	0.3	0.3	0.3	0.6	1.2	37800
CTW3-60-T50-501	500:5	T50	0.3	0.3	0.3	0.6	1.2	37800
CTW3-60-T50-601	600:5	T50	0.3	0.3	0.3	0.6	1.2	37800

* For ordering with primary bars, change model number to CTWH3.
 ** With a burden of B 0.1 or greater connected to the secondary.

Applications

Metering and relaying.

Frequency

50 - 400 Hz.

Maximum System Voltage

5.6kV, BIL 60kV full wave.

Continuous Thermal Current Rating Factor

1.50 at 30° C amb., 1.33 at 55° C amb.

150:5 and 600:5

1.33 at 30° C amb., 1.00 at 55° C amb. 250:5

1.00 at 30° C amb., 0.85 at 55° C amb.

Primary Terminals

1/2-13 bolts with one Belleville washer.

Secondary Terminals

Brass studs No. 10-32 with one flatwasher, lockwasher and regular nut.

Supplied with short circuiting secondary terminal cover

Vacuum cast in polyurethane resin.

Other ratios, secondary currents and dual ratios are available. Refer to factory.

The transformers are tested for partial discharge to Canadian Standards CAN3-C13-M83. This test can also be carried out to IEC requirements if requested.

Approximate weight

20 lbs.

Regulatory Agencies



BAR SIZES		
PRIMARY CURRENT	DIMENSIONS	
	A	B
5 TO 150A	0.19	1.50
200 TO 600A	0.25	2.00



Another HUNTINGTON ELECTRIC Company

CR Magnetics, Inc. 3500 Scarlet Oak Blvd. St. Louis MO USA 63122 V: 636-343-8518 F: 636-343-5119

Web: <http://www.crmagnetics.com>

E-mail: sales@crmagnetics.com

CTW3-60-T50

RECOMMENDED MINIMUM SPACINGS

- A; Unit to Unit
= 0.75" minimum.
- B; HV to Ground in Air
= 3.00" minimum.

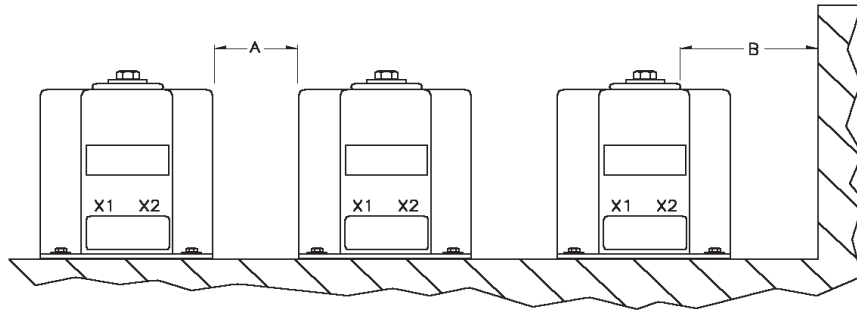

Recommended spacings are for guidance only. User needs to set appropriate values to assure performance for high potential test, impulse test, high humidity, partial discharge, high altitude, and other considerations like configuration.

